

---

# ULTRA VIOLET RADIOMETER

MODEL **UV203**

**USER HANDBOOK**



Handbook Ref No. MH064/Issue K  
File Ref: UV203V5K.doc

 **IRRADIAN**  
Light Measurement Systems & Calibration

---



---

# ULTRA VIOLET RADIOMETER

MODEL **UV203**

**USER HANDBOOK**

- CONTENTS:**
1. Introduction
  2. Specification
  3. Operation
  4. Irradiance Measurements
  5. Cosine Angular Response
  6. Calibration Description
  7. Care and Maintenance
  8. Optional Accessories
  9. Block Diagram
  10. Programming via the RS232 interface
  11. Environmental care, recycling and disposal
-



## 1. INTRODUCTION

The Irradian portable digital UV radiometer model UV203 is a versatile direct reading instrument designed specifically for measuring UV irradiance. It is supplied with a GaAsP solid state detector and a choice of up to three screw in filters to enable measurements to be made across the ultra-violet spectrum.

This instrument is especially useful for monitoring the ultra-violet emissions from high and low pressure mercury vapour lamps, metal halide lamps and ultra violet fluorescent lamps. Other applications include the measurements of germicidal lamps used for sterilization, PUVA lamps used in phototherapy or monitoring industrial ultra-violet lamps used in the curing of inks & adhesives.

Listed below are some of the standard models available:

### MODEL

UV203:	UV203 with detector and three filter rings DET203UV Detector /amplifier UVA-Cos UVB2-Cos IF-254
UV203 A:	UV203 with detector and filter ring DET203UV Detector /amplifier UVA-Cos
UV203 B:	UV203 with detector and filter ring DET203UV Detector /amplifier UVB2-Cos
UV203 AB:	UV203 with detector and filter ring DET203UV Detector /amplifier UVAB-Cos
UV203-254:	UV203 with detector and filter ring DET203UV Detector /amplifier IF-254
UV203 A+B	UV203 with detector and two filter rings DET203UV Detector /amplifier UVA-Cos UVB2-Cos

## 2. SPECIFICATION

DISPLAY UNIT	UV203
Controller:	80C51 8bit micro-processor with a 3.1684MHz clock.
Memory	On board non volatile RAM for calibration factors and set-up parameters.
Key Operation	7 switch key board with 11 LED indicators.
Power Switch	Microprocessor reset at switch on. Unit settings stored prior to shut down.
Serial Interface	Three wire RS232 serial interface. 4800 baud, no parity, 1 stop bit.
Integration Time	0.33s
Conversion Scale	17 bit
Accuracy:	Measurement accuracy $\pm 1$ digit with a linearity error of $< 1\%$ .
Display:	4½ digit lcd display. Character height 10mm.
Power Supply:	9 volt PP3 battery.
Power Consumption:	Shut down mode $< 5\mu\text{A}$ Operating                    10 - 20mA
Battery Life	~ 50 hours.

## 2. SPECIFICATION (continued):

Ranges: Each of the filter rings have up to six ranges according to the table below:  
 Note the UV203A, UV203B, UV203-254 and UV203AB are supplied with only one filter ring.  
 Model UV203 A + B is supplied with two filter rings.

Full Scale \ Filter Ring	UVA	UVB2	IF-254	UVAB
1.9999 mW.m <sup>-2</sup>				
19.999 mW.m <sup>-2</sup>			✓	
199.99 mW.m <sup>-2</sup>	✓		✓	✓
1999.9 mW.m <sup>-2</sup>	✓	✓	✓	✓
19.999 W.m <sup>-2</sup>	✓	✓	✓	✓
199.99 W.m <sup>-2</sup>	✓	✓	✓	✓
1999.9 W.m <sup>-2</sup>	✓	✓	✓	✓
19999 W.m <sup>-2</sup>	✓	✓		✓
19999 x10 W.m <sup>-2</sup>		✓		
<i>Calibration Type:</i>	Standard	Standard	Mercury	Standard

Note: Other filter rings and ranges are available on request.

**Standard Calibration:** The radiometer with detector and filter rings is calibrated at the peak response of each filter ring using a monochromatic source. The calibration plane is at the front of the filter face.

**Mercury Calibration:** The radiometer with detector and filter rings is calibrated at a wavelength corresponding to a mercury emission line. The calibration plane is 34 mm back from the front of the filter face, corresponding to the position of the photodiode.

**Spectroradiometric Cal.** The radiometer with detector and filter rings is calibrated to match the measurement of a spectroradiometer on a particular source.

**Accuracy** Absolute calibration accuracy  $\pm 7.5\%$  traceable to NPL standards.

## 2. SPECIFICATION (continued):

### Front Panel Controls:

*RANGE* Select auto ranging or manual range control.  
*UNITS* Select between UVA or UVB to match the filter ring fitted to the detector.  
 Select AUX for the IF-254 filter ring or special filter rings / accessory if fitted.

*ZERO* Initiates a zero or background measurement routine on all gain ranges.

*HOLD/RUN* Display is held at present reading until HOLD button is pressed again.

*MODE* Select to run or hold a special mode.  
 Select between, AVERAGE, MIN, MAX and INTEGRATE modes. Press RESET to return to normal measurement mode.

*FUNCTION/RESET* Press to reset function values to zero  
*RESET* Press to return to normal measurement mode from Manual range control or special modes.  
 Note the display hold is not reset.

Ⓟ Power on / off button

Connectors: 8 pin DIN type detector connector.  
 5 pin DIN type RS232 connector.

Temperature Range: 0 to 40°C. 80% RH.

Dimensions: 150 x 80 x 45mm.  
 High impact polystyrene.

Weight: 350g



## 2. SPECIFICATION (continued):

### LABORATORY DETECTOR, Model DET203UV

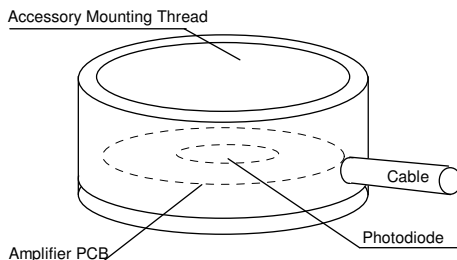

The DET203UV laboratory detector comprises of an aluminium housing, photodiode and PCB assembly.

Detector: 21mm<sup>2</sup> GaAsP photodiode.

Responsivity: Excluding filter rings. Figure 1

Temperature Coefficient: -0.10 %/°C

Amplifier Gain 10<sup>9</sup> V/A to 10<sup>3</sup> V/A

Current to Frequency 0 - 0.5Mhz

Linearity Error: <1% across ranges

Temperature Range: Operation: -10 to +60 °C  
Storage: -20 to +70 °C

Detector Housing: Black anodised aluminium alloy housing.  
Each optical accessory screws into the detector housing on a 1.125" x 20 T.P.I.

Cable: 1 metre cable to 8 pin DIN type connector

## 2. SPECIFICATION (continued):

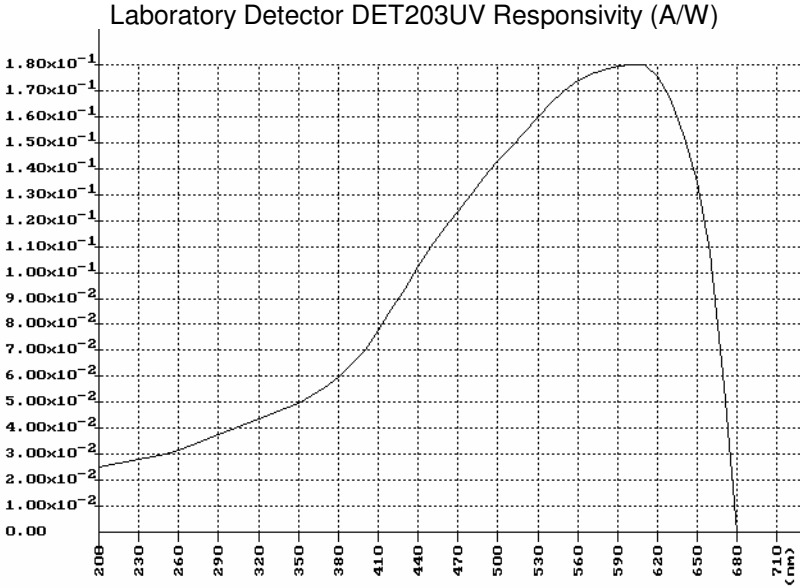
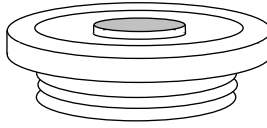

Figure 1

## 2. SPECIFICATION (continued):

UVA FILTER RING, Model UVA-Cos



Spectral Response: Refer Figure 2.  
 $\lambda_{\text{peak}}$  @ 365  $\pm$ 2nm, FWHM 35  $\pm$ 2nm.

Visible & NIR Blocking:  $>10^5$  from 420 to 1000nm

Angular Response: Accurately cosine corrected to Lambert's Cosine Law. Maximum error is less than  $\pm 3.5\%$  from true response to  $70^\circ$  from normal incidence, reference section 5.

Filter ring assembly: Black anodised aluminium alloy ring with screw thread 1.125" x 20 T.P.I.  
 Multiple coloured filter glasses individually selected.  
 Specially profiled diffuser for high accuracy cosine angular response.

DET203UV Detector with UVA-Cos Filter Ring

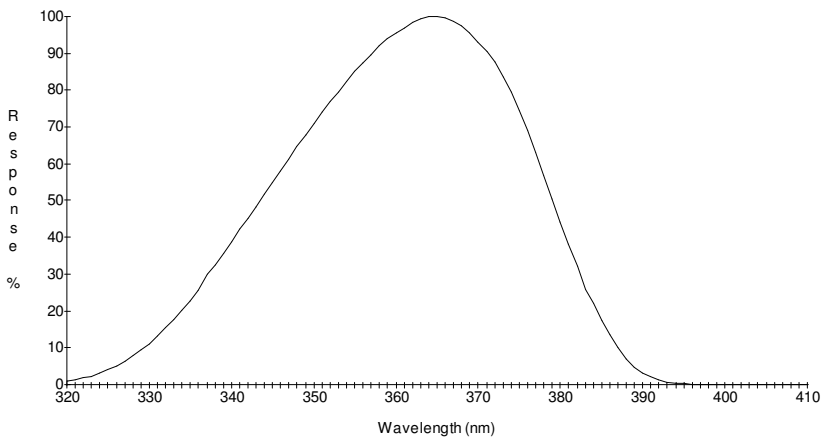
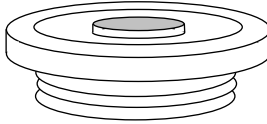

Figure 2

## 2. SPECIFICATION (continued):

UVB FILTER RING, Model UVB2-Cos



Spectral Response: Refer Figure 3.  
 $\lambda_{\text{peak}}$  @ 311  $\pm$ 2nm, FWHM 19  $\pm$ 2nm.

Visible & NIR Blocking:  $>10^5$  from 400 to 1000nm

Angular Response: Accurately cosine corrected to Lambert's Cosine Law. Maximum error is less than  $\pm 3.5\%$  from true response to  $70^\circ$  from normal incidence, reference section 5.

Filter ring assembly: Black anodised aluminium alloy ring with screw thread 1.125" x 20 T.P.I.  
 Multiple coloured filter glasses individually selected.  
 Specially profiled diffuser for high accuracy cosine angular response.

DET203UV Detector with UVB2-Cos Filter Ring

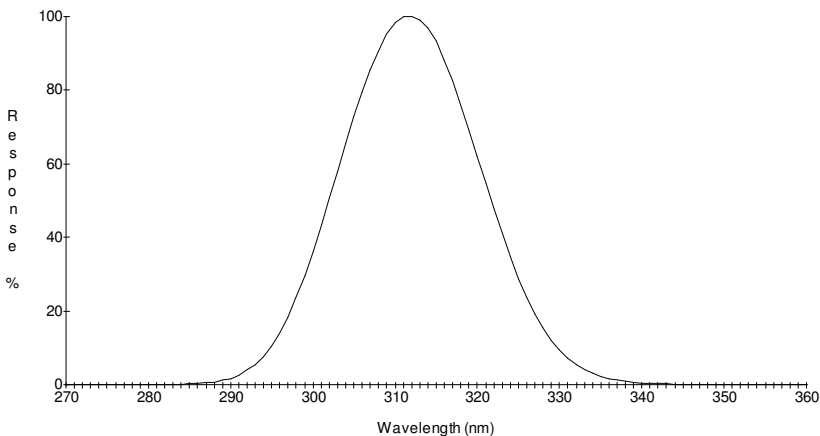
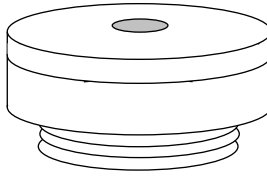

Figure 3

## 2. SPECIFICATION (continued):

254nm FILTER RING, Model IF-254



Spectral Response: Refer Figure 4.  
 $\lambda_{\text{peak}}$  @ 254  $\pm$ 2nm, FWHM 12  $\pm$ 2nm.

Visible & NIR Blocking:  $>10^3$  from 400 to 1000nm for measurements of light at normal incidence.

Filter ring assembly: Black anodised aluminium alloy ring with screw thread 1.125" x 20 T.P.I.

DET203UV Detector with IF-254 Filter Ring

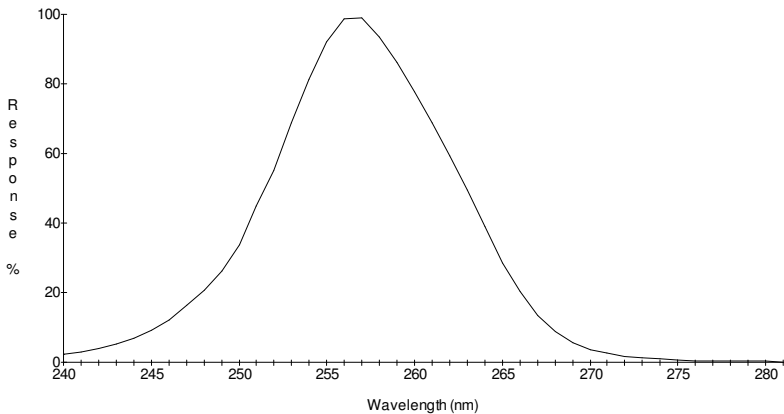
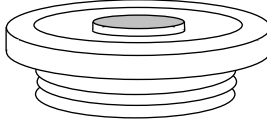

Figure 4

## 2. SPECIFICATION (continued):

### UVAB FILTER RING, Model UVAB-Cos



Spectral Response: Refer Figure 5.  
 $\lambda_{\text{peak}}$  @ 352  $\pm$ 5nm, FWHM 79  $\pm$ 4nm.

Visible & NIR Blocking:  $>10^5$  from 420 to 1000nm

Angular Response: Accurately cosine corrected to Lambert's Cosine Law. Maximum error is less than  $\pm 3.5\%$  from true response to  $70^\circ$  from normal incidence, reference section 5.

Filter ring assembly: Black anodised aluminium alloy ring with screw thread 1.125" x 20 T.P.I.  
 Multiple coloured filter glasses individually selected.  
 Specially profiled diffuser for high accuracy cosine angular response.

DET203UV Detector with UVAB-Cos Filter Ring

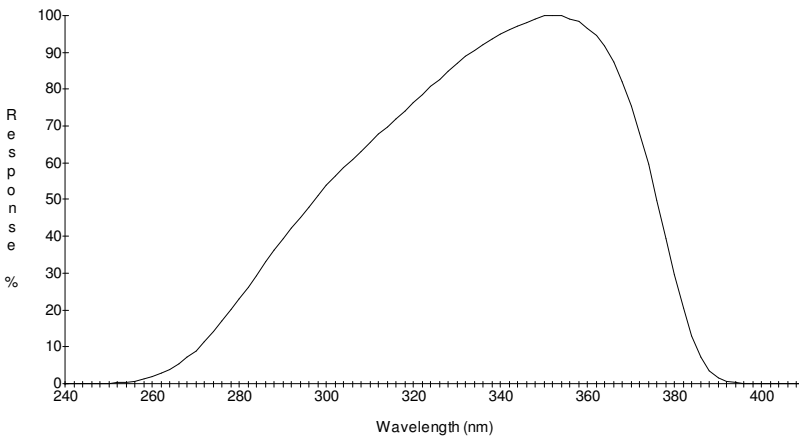

Figure 5

### 3. OPERATION

#### SETTING UP

- 1) With the unit OFF, plug the detector 8 way connector into the socket on the top of the display unit.
- 2) Screw a filter ring on to the detector housing. Note: Carefully clean the white diffuser on the filter rings if they are marked or dirty.
- 3) Press and release the power switch on the UV203 display key pad. The micro controller will initiate with the display momentarily showing:-



The radiometer will now search for the optimum range on the detector amplifier. A typical display is shown below.



An LED will illuminate indicating the filter rings calibration, *UVA*, *UVB* or *AUX* and the units  $mW.m^{-2}$  or  $W.m^{-2}$ . This will be the same filter ring selected prior to the last power off.

- 4) Press and release the *UNITS* switch to select the calibration factor matched to the filter ring fitted to the detector. *UVA* for the UVA filter ring, *UVB* for the UVB2 filter ring and *AUX* for the IF-254 and UVAB filter rings.
- 5) It is recommended that the radiometer amplifier is nulled periodically. Place the cover over the filter ring or the end of the field of view probe. Press and release the *ZERO* switch, the display will momentarily show:-



### 3. OPERATION (continued):

- 6) The micro controller will now measure the amplifier offset on each of the gain ranges and store these values in the non volatile memory. All subsequent measurements will first have one of these offsets subtracted before displaying the measurement.

At the end of the nulling sequence the display will show:-

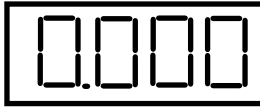

Note if the radiometer units is set to AUX with the IF-254 filter ring the display will show .0000 and with UVB will show 00.00.

- 7) Remove the cover from the detector, the equipment is ready for use.

#### AVERAGE

When the light is unstable, press and release the MODE switch. The radiometer will now switch to manual ranging, Manual LED on, if not yet previously in manual ranging. The *Average* LED will now switch on, but the Units LED will remain unchanged.

To start an average sequence press and release the HOLD/RUN switch. Immediately the display will show a fluctuating signal, reflecting the light source fluctuations. After a short time the amplitude of the fluctuations will decrease and the display will begin to show a reading which represents the average light level during the period of the measurement. At any time the averaging process can be halted by pressing the HOLD/RUN button.

At any time the averaging sequence can be reset by pressing and releasing the FUNCTION RESET switch.

If the light level fluctuations are large and any one reading causes the detector amplifier to overload at this range the averaging process will be terminated and the display will show:-



To avoid an overload conditions *RESET* the radiometer and Manually change the RANGE to a lower gain. e.g. from a 34.00 range to 34.0.



### 3. OPERATION (continued):

#### MIN & MAX LEVELS

During an average measurement sequence the maximum and minimum values attained in the period are recorded. Press *HOLD* to halt the averaging sequence. Press the *MODE* button to select between *Average*, *Min* and *Max*. Note the Integrate display may overload and show - 0 L -.

It is also possible to view a *MIN* or *MAX* recording sequence by selecting *MIN* or *MAX* prior to selecting *RUN*.

Press *FUNCTION RESET* to set the maximum and average values to zero and the minimum to - 0 L -. Note the *FUNCTION RESET* will operate during a measurement sequence or in the *HOLD* mode.

#### INTEGRATE

For measurements of the integrated dosage or exposure press the *MODE* switch to select *Integrate*. Press the *RUN* switch to start the measurement. The display will now autorange as the dosage increases. Note the detector amplifier will not autorange and as with Average measurements if the amplifier overloads the display will show - 0 L - and the measurement will halt.

Units for integrated measurements as shown in blue on the radiometer,  $\text{mJ.m}^{-2}$  and  $\text{J.m}^{-2}$ .

At the end of the integration period *HOLD* the display. Use the *MODE* switch to also display the *Min*, *Max* and *Average* values.

Press *FUNCTION RESET* to set the integrate, maximum and average values to zero and the minimum to - 0 L -. Note the *FUNCTION RESET* will operate during a measurement sequence or in the *HOLD* mode.

## 4. IRRADIANCE MEASUREMENTS

CAUTION: ULTRA VIOLET RADIATION IS HAZARDOUS TO BOTH THE EYES AND SKIN. TAKE CARE TO AVOID PERSONAL EXPOSURE DURING MEASUREMENTS.

Irradiance is the measurement of radiometric light per unit area, watts per metre,  $W/m^2$ . The part of the spectrum to be measured is defined by the filter fitted onto the detector. Ideally this should be a filter with a square spectral response. In practice it rarely is and the filter is defined with a peak response wavelength and a full width half maximum, FWHM bandwidth. In all applications it is vital to know the part of the spectrum being measured by the detector and filter, and if possible to know the spectrum of the light source. In addition the radiometer should be calibrated to best suit the measurement conditions. It may even be necessary to have more than one calibration factor for the same detector / filter combination.

For most applications the measurement plane is horizontal and a cosine corrected diffuser is fitted to the front of the detector assembly. If the working surface is not horizontal then placing the detector on or parallel to the worktop is a more representative measurement of irradiance.

Note that all the light sources in the hemisphere above the detector will contribute to the measurement. The sources may be obvious, lamps or windows or even walls or other reflecting surfaces. Take care not to shadow the detector during all measurements.

The UVA, UVB2 and UVAB filter rings are cosine corrected, however the narrow band interference filter rings do not have a diffuser fitted. Measurement errors will increase as the angle of irradiance increases from the normal to the filter ring front surface.

A useful technique for measuring the sensitivity of the detector filter to non ultra violet light is to place a *high pass* filter glass over the front of the filter ring and record the reading. If the *high pass* filter blocks all the light across the spectral response region of the UV filter then a zero reading would imply the detector/filter is only sensitive to the UV light. Readings other than zero would imply there is some sensitivity to visible or near infra-red light.

## 5. COSINE ANGULAR RESPONSE

Irradiance is a measurement of the amount of light incident on a unit area (watts/m<sup>2</sup>). Any detector will measure this reliably when measuring a beam of light perpendicular to the detectors surface, however, when measuring scattered light or light from an extended source the sensor must have an accurate response over its 180° field of view. More importantly, this response should be proportional to the cosine of the angle of light incident on the detector. This comes from the fact that the projected area of any surface at an angle of  $i$  is proportional to  $\text{Cos}(i)$ .

To ensure that the integration of light from all angles is correct, the cosine diffuser matches the angular response so that response of the detector decreases with  $\text{Cos}(i)$  as the angle between the source and detector increases from 0 to 90°.

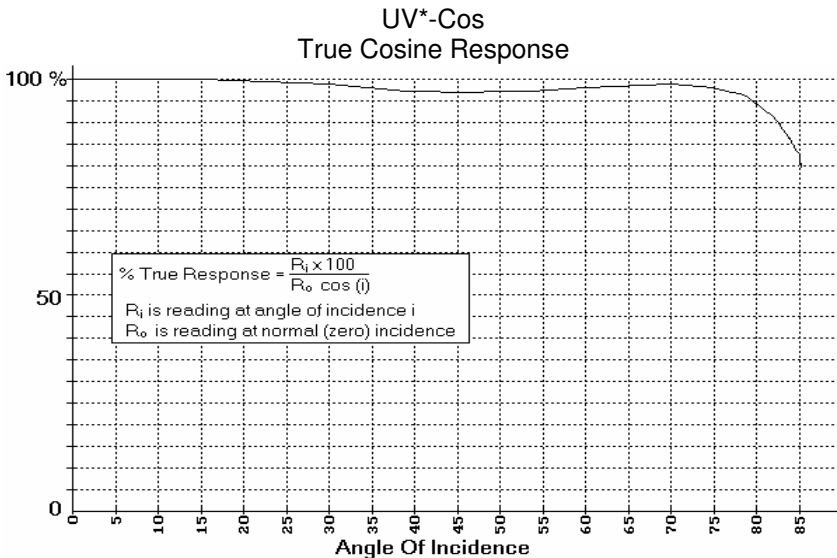

Figure 6

Irradian's cosine diffusers are corrected to match the cosine response to within  $\pm 3.5\%$  up to angles of 70°. This ensures that the meter correctly reads illuminance or visible light flux density whether it is measuring light from an extended or a point source.

## 6. CALIBRATION DESCRIPTION

Irradian holds a number of tungsten halogen and deuterium lamps and a silicon photodiode which are routinely calibrated by the National Physics Laboratory in the UK.

During manufacture each filter ring and detector has its spectral response measured. Changes are made to the filter glasses if the peak wavelength or filter bandwidth exceed the specification limits. A graph of the final filter/detector response is provided. The data on a disk is also available on request for importing to a spreadsheet.

The radiometer with detector and filter rings is calibrated using monochromatic light at the peak wavelength of each filter or at a specified wavelength (ref calibration certificate). Other calibration techniques can be applied to suit the users application. For example matching the radiometer output to the output from a high accuracy spectroradiometer (SR9910) for a particular light source like PUVA tubes.

As with all measuring equipment a routine calibration is recommended, typically annually, but with frequent use by a number of different users a shorter recalibration period may be necessary.

Contact Irradian for any calibration requirements for this product and for further information.

## 7. CARE AND MAINTENANCE

- 1) The UV203 display unit can be cleaned using a moist cloth with detergent. Do not use solvent or alcohol to clean surfaces.
- 2) The diffuser on each filter ring should be kept clean at all times.
- 3) The radiometer is a precision instrument, protect from shocks.
- 4) Avoid supporting the detector by the multi core cable.

## 8. OPTIONAL ACCESSORIES

- 1) A large range of filter rings are available including photoresist response filter rings and narrow band interference filters.
- 2) Special high temperature probe accessories for remote measurement under high intensity lamps.

# 9. BLOCK DIAGRAM

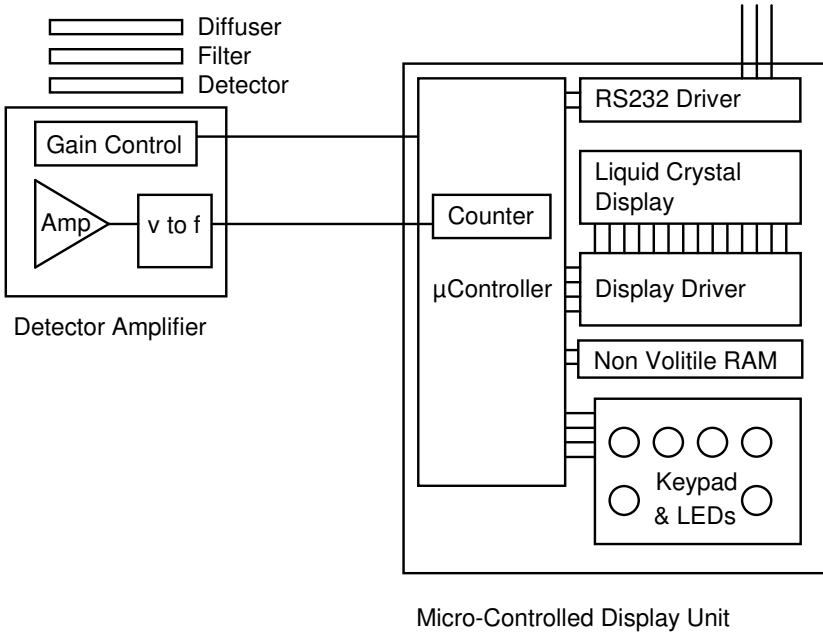

## 10. PROGRAMMING VIA THE RS232 INTERFACE

Serial Port Settings: 4800 baud, no handshaking

Single letter commands

- S Toggle through possible gain ranges (manual mode)  
Reset to autorange with R command.
- U Toggle through possible units, UVA, UVB, etc., as applicable
- F Toggle through possible functions
- I Function reset
- H Toggles hold/go
- Z Zeros light meter
- R Resets light meter
- B Toggles backlight
- s Sends data continuously via the RS232
- o Sends one set of data via the RS232

## 10. PROGRAMMING VIA THE RS232 INTERFACE (continued):

### 10.1 Windows 3.1 & Windows 95

Setting up remote control via Microsoft TERMINAL.EXE

- 1) Connect the cable between the RS232 socket on the light meter and the COM port on the PC.
- 2) Switch on the light meter.
- 3) Run *Terminal* programme.
- 4) Go to the *Settings / Communications* screen and set the baud to 4800 and the COM port to suit.
- 5) Go to the *Settings / Text Transfers* and select *Line at a time* with *1/10th second delay*.
- 6) Check the RS232 link by a switch to the manual range, LED on using the command 'S', (capital S).
- 7) Reset to the auto range, LED off using the command 'R', (capital R).
- 8) Type 'o' for one packet of data and 's' for continuous data. Type 's' to stop the data flow.
- 9) To save the terminal setup go to *File / Save As* and save the settings. When restarting the programme the settings can be reloaded with *File / Load filename*. Now actions 4 and 5 can be omitted.

Logging data continuously to a file using Microsoft TERMINAL.EXE

- 1) Run the Terminal programme with the correct settings.
- 2) Set up the radiometer and send the command 's' via Terminal to transmit data continuously from the radiometer.
- 3) Go to *Transfers / Receive Text File*. Enter filename for the stored data (e.g. log1.txt).
- 4) On entering the file name, Terminal will now store all the readings transmitted from the radiometer in a file *log1.txt*. The file is saved to the computer by pressing STOP on the terminal screen.



## 10. PROGRAMMING VIA THE RS232 INTERFACE (continued):

### 10.2 Windows 95 & Windows 98

Setting up remote control via Microsoft HYPERTERMINAL.EXE

- 1) Connect the cable between the RS232 socket on the light meter and the COM port on the PC.
- 2) Switch on the light meter.
- 3) Run the *HyperTerminal* programme.
- 4) Enter a name for the session (e.g. UV203 etc.).
- 5) Select the type of connection required, either option 'direct to com 1' or 'direct to com 2' depending on which com port is to be used.
- 6) Enter the details for the serial connection: 4800 bits per second, 8 data bits, no parity, 1 stop bit and no flow control.
- 7) Click the properties icon or select via the *File / Properties* option to display the properties window.
- 8) Select the *Settings* tab and select Auto detect for the *Emulation* setting.
- 9) Click the *ASCII Setup* button. Enter 100 into the box marked *Line delay*. No other options are necessary. Click on OK to return to the main window.
- 10) Check the RS232 link by downloading a reading using the command 'o', (lowercase o). This also allows auto detect to correctly identify the meter settings, showing 4800 8-N-1 next to the Auto detect message in the status bar. A reading should appear in the main window if the connection has been made successfully.
- 11) To save the terminal setup go to *File / Save As* and save settings. When restarting the programme the settings can be loaded directly by double-clicking on the \*.ht icon that has been created. Now actions 4 to 9 can be omitted.

## 10. PROGRAMMING VIA THE RS232 INTERFACE (continued):

Logging data to a file using Microsoft HYPERTERMINAL.EXE

- 1) Run the HyperTerminal programme with the correct settings.
- 2) Set up the radiometer and send the command 's' via HyperTerminal to transmit data continuously from the radiometer.
- 3) Go to *Transfer / Capture Text*. Enter the filename for the stored data and the location to save to. (e.g. C:\HyperTerminal\Capture.txt).
- 4) Press the *start* button to store all the readings transmitted from the radiometer in a file *Capture.txt*. The status bar will now show a highlighted 'Capture' message. The file is saved to the computer by selecting *Transfer / Capture Text / Stop*.
- 5) Send the command 's' again via HyperTerminal to stop the continuous transmission of data from the radiometer.

## 11. ENVIRONMENTAL CARE, RECYCLING AND DISPOSAL

The purpose of the European Commission WEEE directive (Waste Electrical and Electronic Equipment; 2002/96/EC) is to ensure that electrical and electronic products are recycled using the best treatments, recovery and recycling techniques that are currently available. This is so that high health standards and a lasting environmental protection can be achieved and maintained.

This product has been designed and manufactured using high quality materials and components, many of which can be recycled and reused.

Please remember to observe the local regulations that govern both the disposal of the packaging materials accompanying this product and any used batteries.



**DO NOT DISPOSE OF THIS PRODUCT IN YOUR GENERAL WASTE BIN.**

Please inform yourself about your local WEEE collection system which is available for electrical and electronic products that are marked with the symbol shown here.

When disposing of this meter, please use one of the following options:

- 1) Use your local designated WEEE collection facilities to dispose of the complete product (including cables, detectors, filters & accessories).
- 2) Return the complete product back to Irradian, marking it clearly as intended for WEEE disposal.









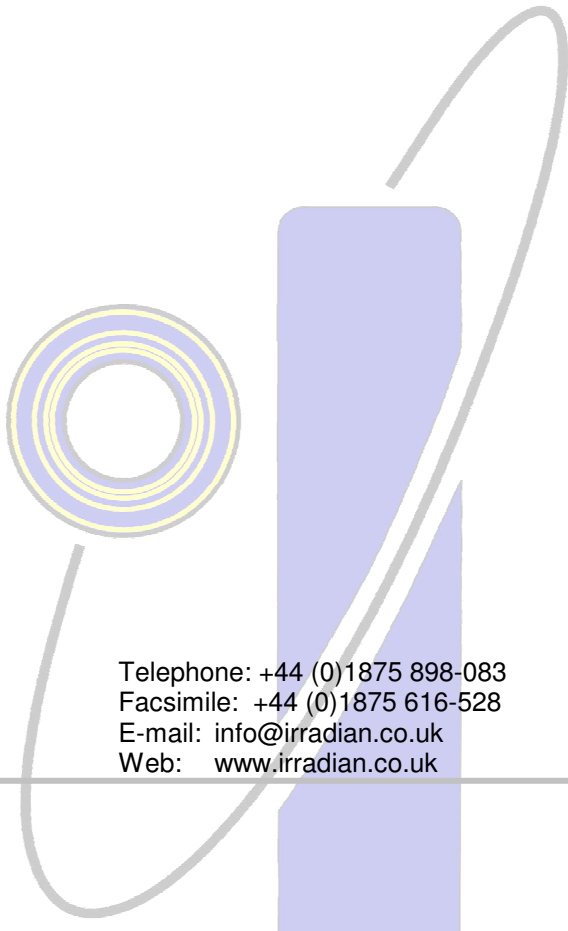

**IRRADIAN Ltd.**

9 Elphinstone Road  
Tranent  
East Lothian  
Scotland EH33 2LG

Telephone: +44 (0)1875 898-083  
Facsimile: +44 (0)1875 616-528  
E-mail: [info@irradian.co.uk](mailto:info@irradian.co.uk)  
Web: [www.irradian.co.uk](http://www.irradian.co.uk)

---